

SINCE 1889



CE

Vacuum Drying Oven

Model: DP23C DP33C DP43C DP63C

- Second Edition -

- Thank you for purchasing " Vacuum Drying Oven, DPC Series" of Yamato Scientific Co., Ltd.
- To use this unit properly, read this "Instruction Manual" thoroughly before using this unit. Keep this instruction manual around this unit for referring at anytime.

⚠WARNING!:

Carefully read and thoroughly understand the important warning items described in this manual before using this unit.

Yamato Scientific Co.,Ltd.

◆ Cautions in Using with Safety	1
• Explanation.....	1
• Table of Illustrated Symbols	2
• Fundamental Matters of "WARNING!" and "CAUTION!"	3
◆ Before Using this unit	4
• Requirements for Installation.....	4
◆ Description and Function of Each Part	9
• Main Unit	9
• Control Panel.....	10
• Characters of the Controller	11
◆ Operation Method	12
• Operation Mode and Function List	12
• Operation Mode, Function Setting Key, and Characters	14
• Setting of Overheating Prevention Device	15
• Fixed Temperature Operation.....	16
• Quick Auto Stop Operation	17
• Auto Stop Operation	19
• Auto Start Operation.....	21
• Program Operation.....	23
• Other Functions.....	30
• Vacuumizing and air intake.....	31
◆ Handling Precautions	32
◆ Maintenance Method	34
• Daily Inspection and Maintenance	34
◆ Long storage and disposal	35
• When not using this unit for long term / When disposing	35
◆ In the Event of Failure	36
• Safety Device and Error Code.....	36
• Trouble Shooting	37
◆ After Service and Warranty	38
◆ Specification	39
◆ Wiring Diagram	40
◆ Reference Capability Guideline	42
◆ Replacement Parts Table	44
◆ Reference	45
• List of Dangerous Substances	45

Explanation

MEANING OF ILLUSTRATED SYMBOLS

Illustrated Symbols

Various symbols are used in this safety manual in order to use the unit without danger of injury and damage of the unit. A list of problems caused by ignoring the warnings and improper handling is divided as shown below. Be sure that you understand the warnings and cautions in this manual before operating the unit.

 **WARNING!** If the warning is ignored, there is the danger of a problem that may cause a serious accident or even fatality.

 **CAUTION!** If the caution is ignored, there is the danger of a problem that may cause injury/damage to property or the unit itself.

Meaning of Symbols



This symbol indicates items that urge the warning (including the caution). A detailed warning message is shown adjacent to the symbol.



This symbol indicates items that are strictly prohibited. A detailed message is shown adjacent to the symbol with specific actions not to perform.



This symbol indicates items that should be always performed. A detailed message with instructions is shown adjacent to the symbol.

Cautions in Using with Safety

Table of Illustrated Symbols

Warning



Warning,
generally

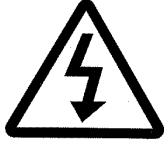

Warning,
high voltage



Warning,
high temperature



Warning,
drive train



Warning,
explosive

Caution



Caution,
generally



Caution,
electrical shock



Caution,
scald



Caution,
no road heating



Caution,
not to drench



Caution,
water only



Caution,
deadly poison

Prohibit



Prohibit,
generally



Prohibit,
inflammable



Prohibit,
to disassemble



Prohibit,
to touch

Compulsion



Compulsion,
generally



Compulsion,
connect to the
grounding
terminal



Compulsion,
install on a flat
surface



Compulsion,
disconnect the
power plug



Compulsion,
periodical
inspection

Cautions in Using with Safety

Fundamental Matters of "WARNING!" and "CAUTION!"

WARNING!

Do not use this unit in an area where there is flammable or explosive gas

Never use this unit in an area where there is flammable or explosive gas. This unit is not explosion-proof. An arc may be generated when the power switch is turned on or off, and fire/explosion may result. (Refer to page 45 "List of Dangerous Substances".)

Always ground this unit

Always ground this unit on the power equipment side in order to avoid electrical shock due to a power surge.

If a problem occurs

If smoke or strange odor should come out of this unit for some reason, turn off the power key right away, and then turn off the circuit breaker and the main power. Immediately contact a service technician for inspection. If this procedure is not followed, fire or electrical shock may result. Never perform repair work yourself, since it is dangerous and not recommended.

Do not use the power cord if it is bundled or tangled

Do not use the power cord if it is bundled or tangled. If it is used in this manner, it can overheat and fire may be caused.

Do not process, bend, wring, or stretch the power cord forcibly

Do not process, bend, wring, or stretch the power cord forcibly. Fire or electrical shock may result.

Substances that can not be used

Never use explosive substances, flammable substances and substances that include explosive or flammable ingredients in this unit. Explosion or fire may occur. (Refer to page 45 "List of Dangerous Substances".)

Do not disassemble or modify this unit

Do not disassemble or modify this unit. Fire or electrical shock or failure may be caused.

Do not touch high-temperature parts

The inside of the body or the door may become hot during and just after operation. It may cause burns.

CAUTION!

During a thunder storm

During a thunderstorm, turn off the power key immediately, then turn off the circuit breaker and the main power. If this procedure is not followed, fire or electrical shock may be caused.

Requirements for Installation

WARNING!

1. Always ground this unit



- The DP23C/33C/43C/63C type use a single-phase 220V power source. Please consult your local electrical contractor for power connecting work.



- Be sure to connect the earth wire (the green cable of power cord) to the grounding conductor or ground terminal to prevent accidents caused by electric leakage.
- Do not connect the earth wire to gas or water pipes. If not, fire disaster may be caused.
- Do not connect the earth wire to the ground for telephone wire or lightning conductor. If not, fire disaster or electric shock may be caused.
- Do not use a branching receptacle, which may cause the heat generation.

2. Choose a proper place for installation



- Do not install this unit in a place where:
 - ◆ Rough or dirty surface.
 - ◆ Flammable gas or corrosive gas is generated.
 - ◆ Ambient temperature exceeds 35°C.
 - ◆ Ambient temperature fluctuates violently.
 - ◆ There is direct sunlight.
 - ◆ There is excessive humidity and dust.
 - ◆ There is a constant vibration.



- Install this unit on a stable place with the space as shown below.
The exhausted opening is provided at the back surface of unit for DP23C/33C/43C/63C types.

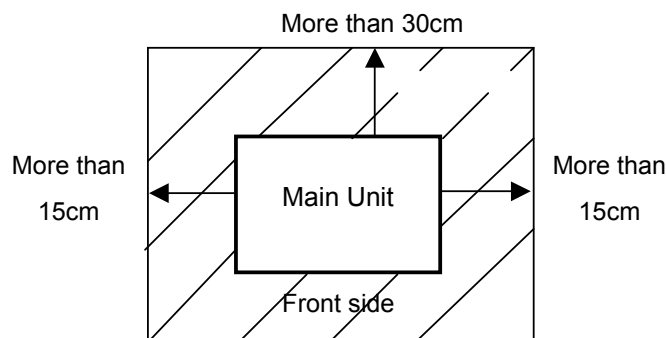

Requirements for Installation

3. Do not use this unit in an area where there is flammable or explosive gas (Refer to page 45 "List of Dangerous Substances".)



- Never use this unit in an area where there is flammable or explosive gas. This unit is not explosion-proof. An arc may be generated when the power switch is turned ON or OFF, and fire/explosion may result.

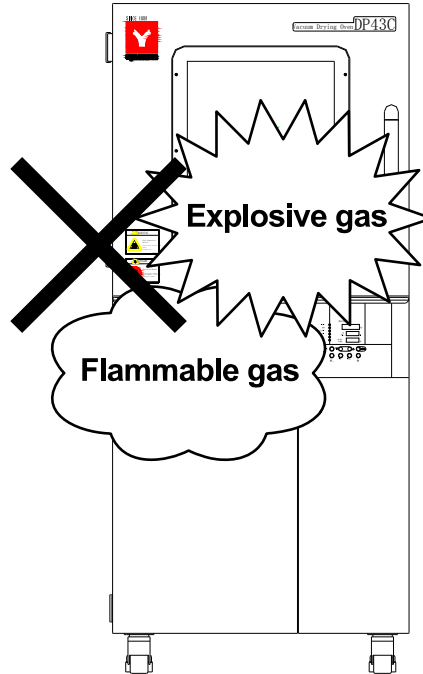
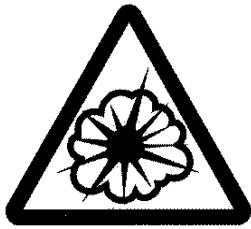

- Never use explosive substances, flammable substances and substances that include explosive or flammable ingredients in this unit. Explosion or fire may occur.

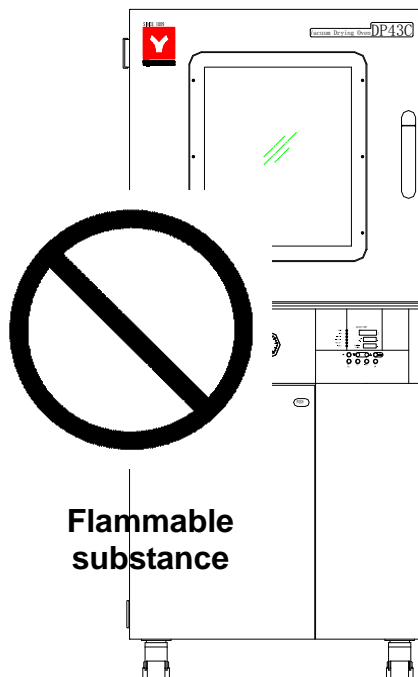
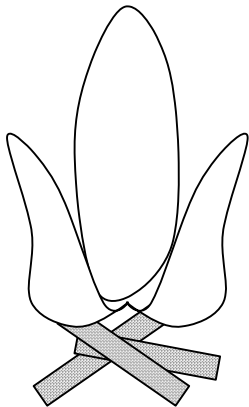

Requirements for Installation

4. Do not modify



- Modification of this unit is strictly prohibited. This could cause a failure.

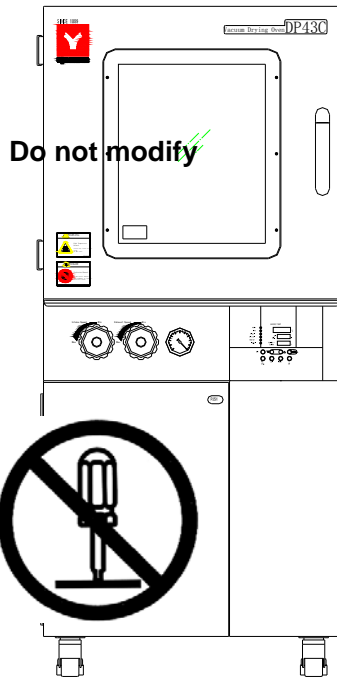

5. Installation on horizontal surface



- Set this unit to the flattest place. Setting this unit on rough or slope place could cause the vibration or noise, or cause the unexpected trouble or malfunction.

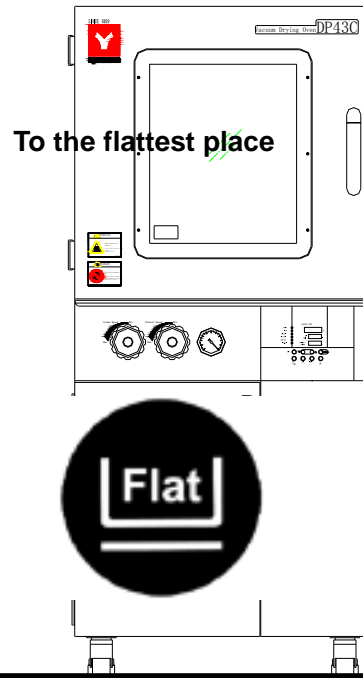

CAUTION!

6. Do not make an overload



- The withstand load of shelf is 15kg (uniform load) Set the samples apart each other.

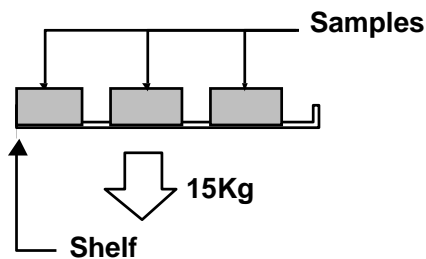

7. Do not set samples in close formation



- The temperature in furnace cannot be controlled if too much samples are set there. Make sure to use the shelf and set samples apart each other so as to make the free space of 30% or more to the furnace to acquire accuracy of temperature.

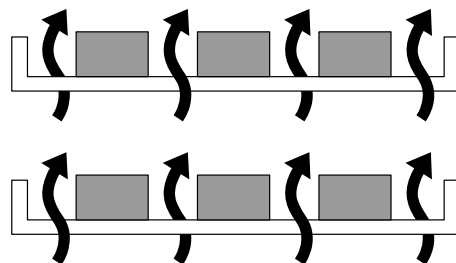

Make the free space of 30% or more

Requirements for Installation

8. Choose a correct power distribution board or receptacle



- Choose a correct power distribution board or receptacle that meets the unit's rated electric capacity.

Electric capacity:	DP23C: 220V AC, 4A	DP33C: 220V AC, 5A
	DP43C: 220V AC, 10.5A	DP63C: 220V AC, 14.5A

NOTE:

There could be the case that the unit does not run even after turning ON the power. Inspect whether the voltage of the main power is lowered than the specified value, or whether other device(s) uses the same power line of this unit. If the phenomena might be found, change the power line of this unit to the other power line. Please consult your dealer or a local electrical contractor for the connection of devices that use a single-phase 220V power source.

9. Before/after installing



- It may cause injure to a person if this unit falls down or moves by the earthquake and the impact. etc..To prevent, take measures that the unit cannot fall down, and not install to busy place.
- Touching the unit may cause a burn during and just after the operation. To prevent, take measures that putting up a notice of operating etc..

10. Handling of power code



- Do not entangle the power cord. This will cause overheating and possibly a fire.
- Do not bend or twist the power cord, or apply excessive tension to it. This may cause a fire and electrical shock.
- Do not lay the power cord under a desk or chair, and do not allow it to be pinched in order to prevent it from being damaged and to avoid a fire or electrical shock.
- Keep the power cord away from any heating equipment such as a room heater. The cord's insulation may melt and cause a fire or electrical shock.



- If the power cord becomes damaged (wiring exposed, breakage, etc.), immediately turn off the power at the rear of this unit and shut off the main supply power. Then contact your nearest dealer for replacement of the power cord. Leaving it may cause a fire or electrical shock.
- Connect the power plug to the receptacle which is supplied appropriate power and voltage.

Requirements for Installation

12. List of vacuum pump plumbing

Item Modle of vacuum oven	Maker	Modle of Suitable vacuum pump	Nipple for suction port of vacuum pump	Necessary plumbing part
DP23C/33C (Nipple of vacuum oven for connecting vacuum hose: Dia. 18mm)	Yamato	PD (PX) 52 ^{*1}	Dia. 18mm	Vacuum hose: I. D. 15mm 1pc
		PD (PX) 102 PD (PX) 136 ^{*1}	Dia. 30mm	Vacuum hose: I. D. 15mm 1pc Vacuum hose: I. D. 25mm 1pc Reducer, AorC (Dia. 18mm/ Dia. 30mm) 1pc
DP43C/63C (Flange of vacuum oven for connecting vacuum hose: NW25)	Yamato	PD (PX) 136 ^{*1} PD (PX) 201 ^{*1}	Dia. 30mm	Vacuum hose: I. D. 25mm 1pc Rubber tube adapter: 1pc Clamp (NW25/30): 1pc Center ring (NW25): 1pc
	Yamato	2ZX-4B, 220V	NW25 flange	Flexible hose: 1pc Clamp (NW25/30): 1pc Center ring (NW25): 1pc
	Mitsubishi	VP-SW -A200 (S) -A310 (S)	NW25 flange	Flexible hose: 1pc Clamp (NW25/30): 2pc Center ring (NW25): 2pc

Description and Function of Each Part

Main Unit

DP43C/63C

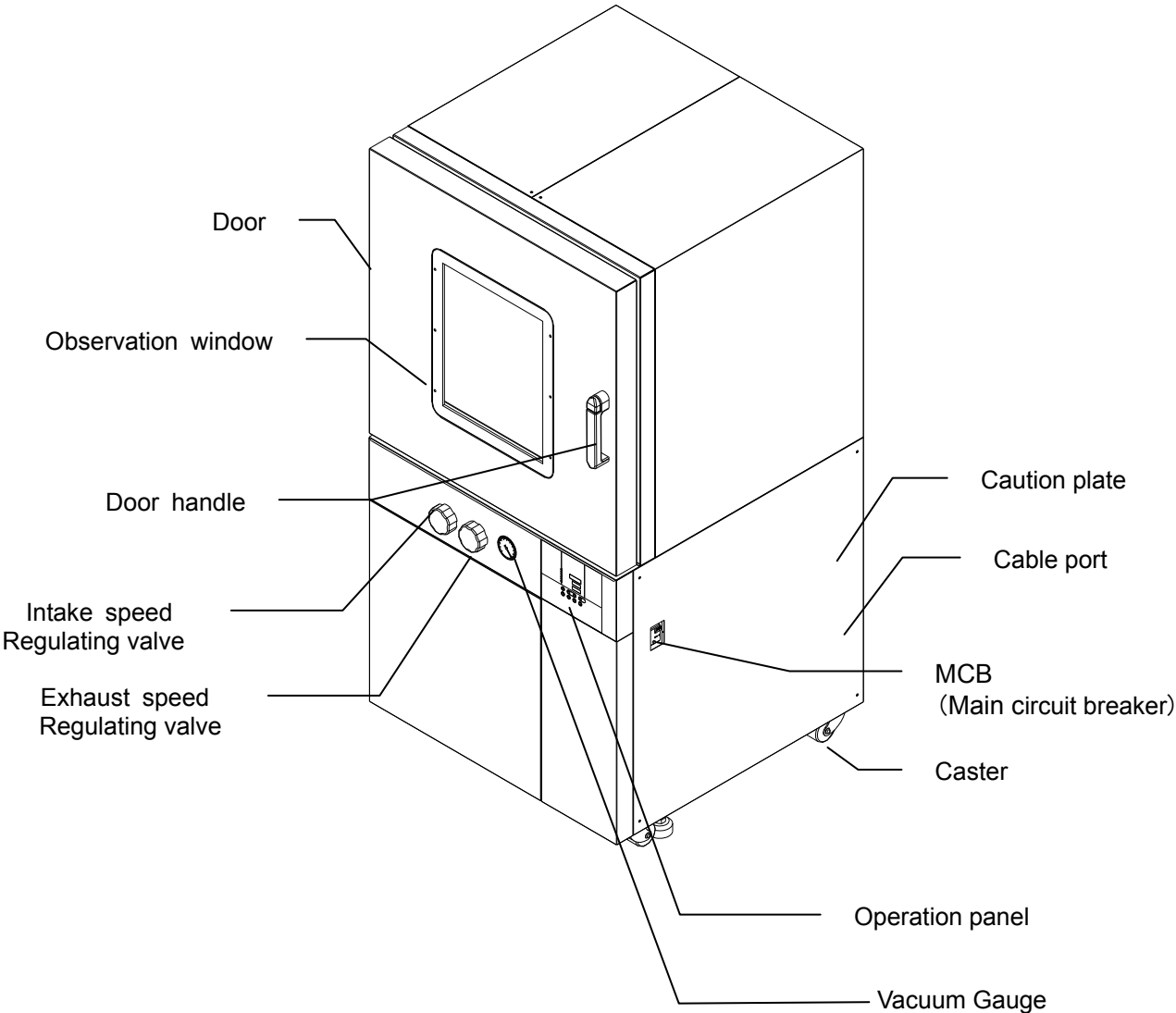

Description and Function of Each Part

Control Panel

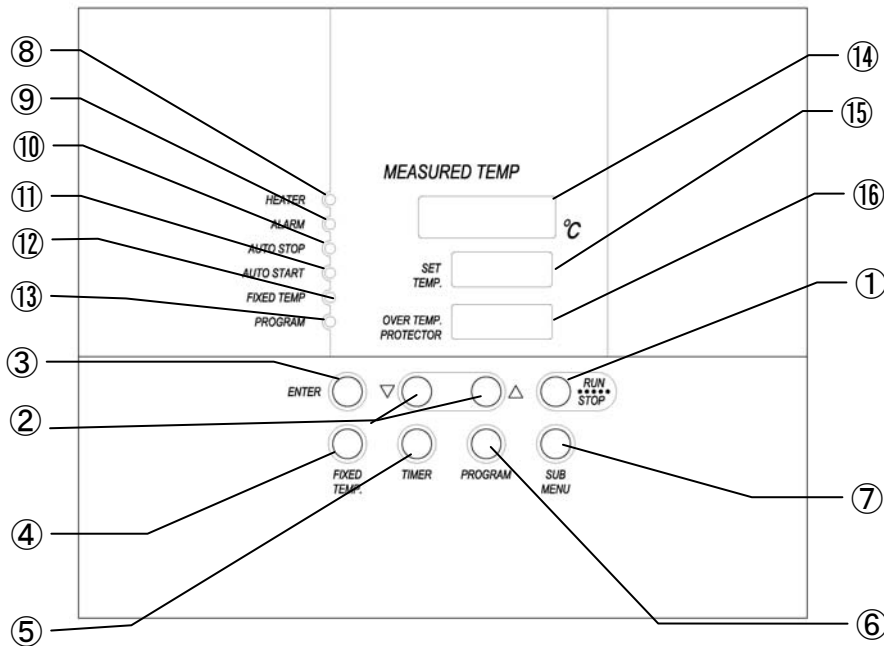













①	START/STOP Key :	Starts/stops the operation.
②	▲▼ Key :	Uses for rising UP/lowering DOWN the setting value.
③	ENTER Key :	Settles the inputted value.
④	FIXED TEMP Key :	Chooses the fixed temperature operation.
⑤	TIMER Key :	Chooses the timer operation (Quick Auto Stop/Auto Stop/Auto Start).
⑥	PROGRAM Key :	Chooses the program operation or program creation mode.
⑦	SUBMENU Key :	Uses for setting the overheating prevention temperature, calibration offset temperature, key lock function, or program repeat function.
⑧	HEATER Lamp :	Lights while the heater works.
⑨	ALARM Lamp :	Lights up when an error occurs. (Buzzer sounds simultaneously.)
⑩	AUTO STOP Lamp :	Blinks while setting quick auto stop timer or auto stop timer. Lights while quick auto stop timer or auto stop timer is running.
⑪	AUTO START Lamp :	Blinks while setting auto start timer. Lights while auto start timer is running.
⑫	FIXED TEMP Lamp :	Blinks while setting fixed temperature operation. Lights while fixed temperature operation is running.
⑬	PROGRAM Lamp :	Blinks while setting program operation. Lights while program operation is running.
⑭	Measurement Temperature Display :	Displays the measured temperature, setting character, alarm information.
⑮	Setting Temperature Display :	Displays the setting temperature, setting value for timer mode, remaining time.
⑯	Overheating Prevention Temperature Display :	Displays the setting temperature for overheating prevention device.

Description and Function of Each Part

Characters of the Controller

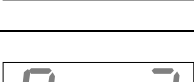
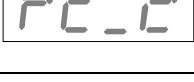
The characters VS6 controller shows are as follows:

Character	Identifier	Name	Purpose
	FiX	Fixed Temperature Setting Mode	Used for starting the fixed temperature operation.
	Sv	Temperature Setting	Used for setting the temperature.
	AStP	Timer Setting Mode Display	Represents the setting of quick auto stop or auto stop operation.
	AStr	Timer Setting Mode Display	Represents the setting of auto start operation.
	tim	Time Setting	Used for setting the time.
	PrG3	Program Type	Used for choosing program type from 1 to 3. (Refer to Page 23 " Program Operation".)
	PAt	Program Pattern	Used for choosing program pattern. (Refer to Page 23 " Program Operation".)
	End	Time Up	Displays when the timer operation is completed or while inputting number of program steps. (Refer to Page 23 " Program Operation".)
	Sv-1	Program Temperature Setting	Used for setting the temperature for each step in the program. (Sv-1 to Sv-30 is shown.)
	t-1	Program Time Setting	Used for setting the time for each step in the program. (t-1 to t-30 is shown.)
	PS-3	Step Number to be Repeated	Used for choosing the step number to be repeated under the program operation with repeat function. (Refer to Page 27 " Use program repeat function".)
	Pc-2	Repeating Times	Used for setting the repeating times under the program operation with repeat function. (Refer to Page 27 " Use program repeat function".)
	cAL	Calibration Offset Setting	Used for inputting the calibration offset temperature. (Refer to Page 30 "Other Function".)
	oH	Overheating Prevention Setting	Used for setting temperature for overheating prevention device. (Refer to Page 15 "Setting of Overheating Prevention Device".)
	LocK	Key Lock	Locks the keys on control panel to protect from unnecessary operation. (Refer to Page 30 "Other Function".)

* Also refer to Page 14 "Operation Mode, Function Setting Key, and Characters".

Operation Mode and Function List

All the operation mode of this unit is as follows;

No.	Name	Description	Page
1.	Fixed Temperature Operation	Pressing the FIXED TEMP key enters into the fixed temperature operation setting mode. Pressing it again enters into the temperature setting mode. The "▲▼" are used to set temperature. Pressing the START/STOP key starts or stops operation.	16
2.	Quick Auto Stop Operation	This operation is used to specify the period up to automatic stop during operation. The period up to operation stop can be set by pressing the TIMER key during fixed temperature operation. The "▲▼" are used to set the time. Pressing the START key starts the quick auto stop operation, activates the timer function and stops the operation automatically after specified period.	17
3.	Auto Stop Operation	This operation is used to specify the automatic stop time in the fixed temperature operation. Pressing the TIMER key displays "AStp". The setting temperature "SV" can be set by pressing the ENTER key. The operation time "tim" can be set by pressing it again. Pressing the START/STOP key starts the auto stop operation.	19
4.	Auto Start Operation	This operation is used to specify the period up to automatic start after power on. Pressing the TIMER key displays "AStr". The setting temperature "SV" can be set by pressing the ENTER key. The operation time "tim" can be set by pressing it again. Pressing the START/STOP key starts the auto start operation.	21
5.	Program Operation	This operation is used to change the temperature according to the setting temperature and time. Pressing the PROGRAM key displays "PrG1". Press it again to select the program mode. Press the ENTER key to select the pattern "PA1". Press the ENTER key to display "End". Input the number of patterns to be used. Input the temperature and time of patterns "SV-n" and "t-n" respectively.	23

NOTE) This unit is impossible to be changed the mode during the operation. If the mode requires to be changed, stop the operation.

Operation Mode and Function List

The operation function of this unit is as follows;

No.	Name		Description	Page
1.	Overheating prevention function	Auto overheating prevention function	This function is set to be automatically activated (auto reset) when the temperature exceeds the setting temperature by 12°C.	15
		Overheating prevention device	Though the device shares power source, display, and key input with the controller, it has independent temperature measurement circuit, CPU, sensor and output circuit. Overheating prevention temperature can be set using the operation panel. The unit stops operation when the device is activated. The unit starts operation again when the POWER switch is pressed again (manual reset).	
2.	Calibration offset function		This calibration offset function is for calibrating the difference occurred between the required in- furnace temperature and control temperature (sensor temperature) of the controller. This unit can be calibrated toward either plus side or minus side of the whole temperature range.	30
3.	Overheating prevention temperature calibration function		The temperature of overheating prevention device is automatically corrected when the temperature of controller is collected.	-
4.	Recovery at power failure		The unit starts operation with the same condition as just before power failure if it occurs during operation. Press the START/STOP key to start the unit again.	-
5.	Setting value locking		This function locks the established operation status. It can be set and cancelled with the SUBMENU key.	30

Operation Mode, Function Setting Key, and Characters

The operation mode setting and function setting use the key operation and characters show in the following figure.

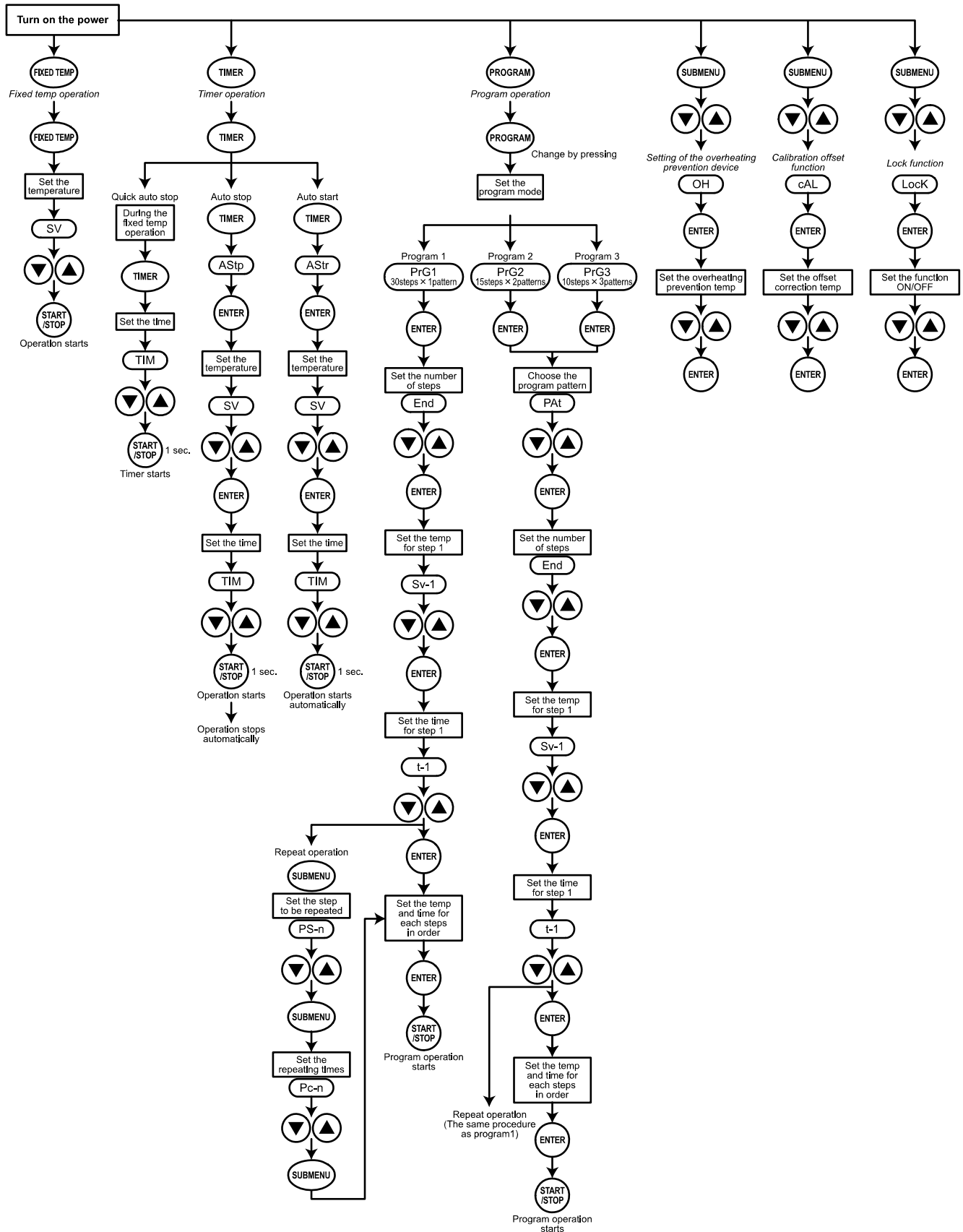

Setting of Overheating Prevention Device

The unit has the overheating prevention device (manual reset) that consists of independent temperature measurement circuit, CPU, sensor and output circuit (it shares power source, display, and key input with the controller) in addition to the automatic overheating prevention function (auto reset) in the controller.

Setting range/function

The unit has failsafe functions against overheating. One of them is built in the controller and previously set at factory shipment so to be automatically activated when the temperature exceeds the setting temperature of temperature controller by 12°C, where the heater repeats on and off.

The other is united with the controller, which can be set by operating the keys on the controller.

The setting range of latter is from 0°C to max set temperature of main controller + 50°C.

In case the temperature in furnace exceeds the setting temperature of controller to reach to that of overheating prevention device, the circuit is shut off and "Er19" is displayed with blinking on the screen of controller with buzzer sound.

If the device is once activated, "Er19" continues to be displayed until the power is newly turned on.

Temperature setting procedure

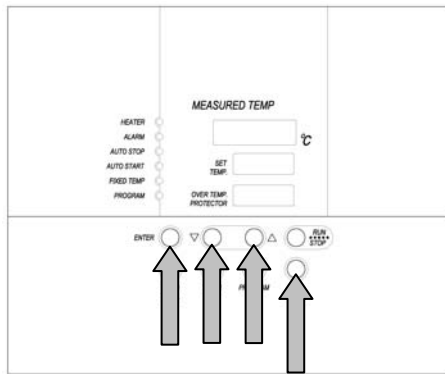

1. Turn on the power (turn on the breaker in front)

- The default value is displayed for about four seconds after turning on the power. The screen then displays the initial setting. The current temperature in furnace, operation mode character and setting temperature of overheating prevention device are displayed on respective screens.

2. Set the temperature for overheating prevention

- ① Press the SUBMENU key.
- ② Press the "▼▲" several times to select the setting character of overheating prevention temperature "OH".
- ③ Press the ENTER key. The current setting temperature is displayed with blinking on the setting temperature screen.

Note: To prevent improper operation, set the value 10°C or more over the setting temperature of controller.

- ④ Select the value using the "▼▲" and then press the ENTER key. This completes the setting.

Notes:



- The standard setting temperature of device is "the maximum setting temperature of unit plus 20°C" or "setting temperature plus 20°C". If the unit performs improper operation, increase it 5°C more.
- The setting range of overheating prevention device is from 0°C to max set temperature of main controller + 50°C. Improper setting of temperature may cause inoperative of unit, malfunction of device, e.g. it is activated during increasing in temperature in furnace, or unexpected accidents such as fire disaster. To prevent such matters, set a proper value. **The DP23C/33C temperature is set to 260°C at factory shipment (The DP43C/63C temperature is 220°C). Do not set the value larger than it.**
- In some case, the overheating prevention device is possible to be activated by mistake when its yield temperature is set to around room temperature.
- The purpose of overheating prevention device is to protect the unit from overheating. It does not intend to protect the samples, or to protect them from the accident caused by the use of explosive or inflammability.

Fixed Temperature Operation

Fixed temperature operation procedure

1. Turn on the power (turn on the breaker in front)

- ❖ The default value is displayed for about four seconds after turning on the power. The screen then displays the initial setting. The current temperature in furnace, operation mode character and setting temperature of overheating prevention device are displayed on respective screens.

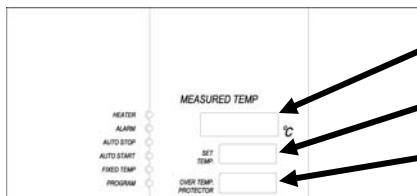

Measurement temperature screen:

Displays the current temperature in furnace.

Setting temperature screen:

Displays the operation mode character. (Refer to Page 11)

Overheating prevention screen:

Displays the setting temperature of overheating prevention device

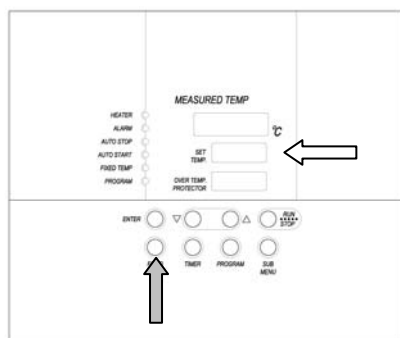

2. Select the operation mode

- Press the FIXED TEMP key to display "FIX", which indicates the fixed temperature operation, on the center display screen.

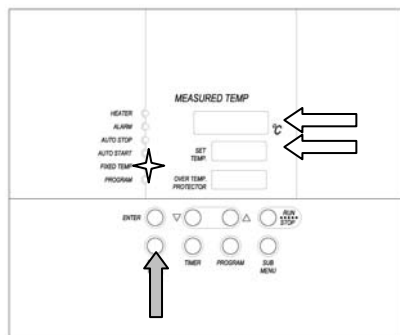

3. Set the temperature

- Press the FIXED TEMP key again.
- The setting temperature screen displays the character "SV" which indicates the temperature setting. Also it displays the current setting temperature with blinking. The FIXED TEMP lamp blinks, too.
- Set the temperature by pressing the "▼▲".

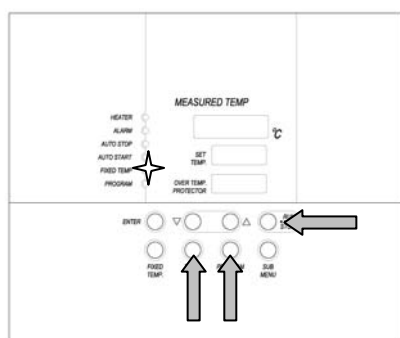

4. Start operation

- Press the orange START/STOP key for about one second. The unit starts operation and the blinking FIXED TEMP lamp lights on.

5. Stop operation

- Press the orange START/STOP key for about one second. The unit stops operation and the FIXED TEMP lamp lights off. The screen returns to the initial setting screen.

To correct or check setting...

Press the FIXED TEMP key again to correct or check the setting.

Changing the setting temperature during operation is also possible by pressing the FIXED TEMP key.

Quick Auto Stop Operation

Quick auto stop operation procedure

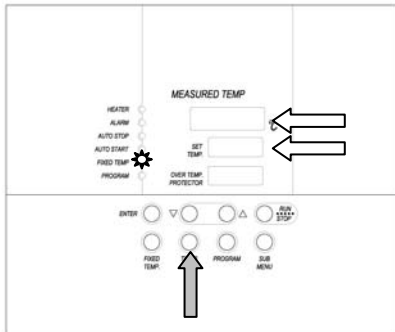

This operation is used to specify the period up to automatic stop, i.e., sets the auto stop timer during operation.

1. Set the time up to stop during fixed temperature operation

- Check that the FIXED TEMP lamp lights on and that the unit is under operation.
- Press the TIMER key.
- The measurement temperature display screen displays the character "tim", which indicates the timer setting. The setting temperature display screen displays the current setting time with blinking.
- Select the time by pressing the "▼▲".

Timer function:

- The maximum setting time is "999hours and 50 minutes".
- The time can be set in increments of a minute under 99 hours and 59 minutes.
- It can be set in increment of ten minutes over 100 hours.
- The "▼▲" can change the setting time quickly when it is pressed continuously. Press them discontinuously when fine adjustment is needed.

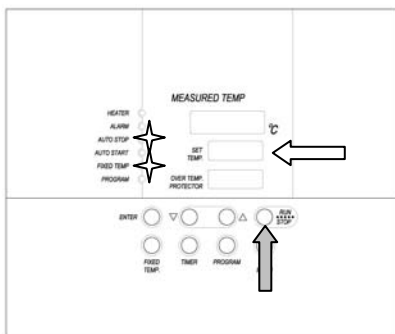

2. Start timer operation

- Press the START/STOP key for one second after deciding the time.
- Timer operation starts with the FIXED TEMP and AUTO STOP lamps lighting on.
- The timer is activated at the point when the START/STOP key is pressed.

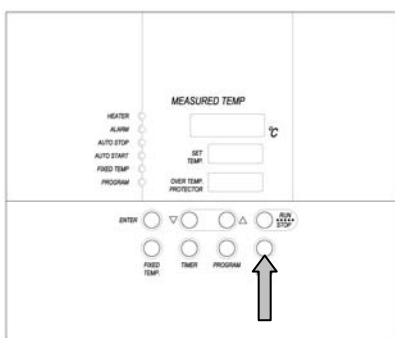

3. Stop/terminate timer operation

- The operation stops automatically at setting time.
- Buzzer continues to sound for about five minutes at operation stop.
- The setting temperature screen displays the character "End", which indicates termination of operation, with the FIXED TEMP and AUTO STOP lamps lighting on. Press the START/STOP key to terminate the timer operation mode. The screen returns to the initial setting screen.

Quick Auto Stop Operation

Change the set temp. and set time, confirm the set value

If need to change the set temp. during quick auto stop operation, press FIXED TEMP key to enter the setting mode.

If need to change the set time during quick auto stop operation, press TIMER key to enter the setting mode.

① After changing the time, press TIMER.

The remaining time on the timer is the time subtracting the elapsed time.

For example: set timer as 1hr30min, conduct quick auto stop operation, after 20min, change the set time to be 2hr, set it by TIMER, the remaining time is 1hr40min.

② After changing the time, press START/STOP for 1sec.

The quick auto stop operation proceeds again as per the changed time.

For example: set timer as 1hr30min, conduct quick auto stop operation, after 20min, change the set time to be 2hr, press START/STOP to set, the remaining time is 2hr.

Press ▼ key, switch over to display the set temp., operation mode and remaining time of set temp. displayer.

Auto Stop Operation

Auto stop operation procedure

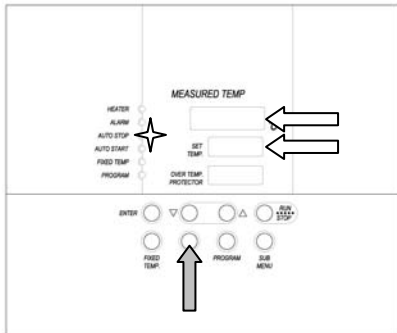

This operation is used to specify the automatic stop time in the fixed temperature operation.

1. Set stop time

- ① Press the TIMER key on the initial screen.
Press the TIMER key again. The setting temperature display screen displays the character "AstP", which indicates the auto stop operation, with blinking.
- ② Press the ENTER key.
The measurement temperature screen displays the character "SV", which indicates the temperature setting. The setting temperature screen displays the current setting temperature with blinking. The AUTO STOP lamp blinks, too.
- ③ Set the temperature using the "▼▲".
- ④ Press the ENTER key again.
The measurement temperature display screen displays the character "tim", which indicates the timer setting. The setting temperature display screen displays the current setting time with blinking.
- ⑤ Set the time using the "▼▲".

Timer function:

- The maximum setting time is "999hours and 50 minutes".
- The time can be set in increments of a minute under 99 hours and 59 minutes.
- It can be set in increment of ten minutes over 100 hours.
- The "▼▲" can change the setting time quickly when it is pressed continuously. Press them discontinuously when fine adjustment is needed.

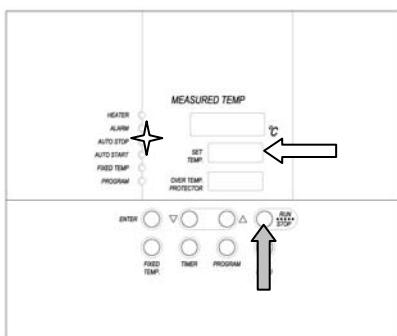

2. Start timer operation

- Press the START/STOP key for one second after deciding the time.
- Timer operation starts with the AUTO STOP lamp lighting on.
- The timer is activated at the point when the temperature in furnace (measurement temperature) reaches to the setting temperature.

Auto Stop Operation

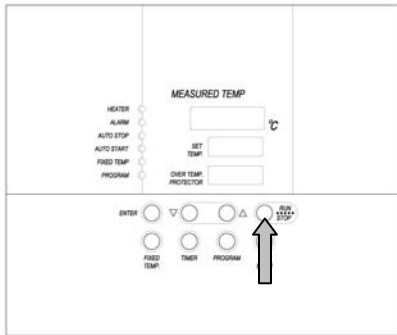

3. Stop/terminate timer operation

- The operation stops automatically at setting time.
- Buzzer continues to sound for about five minutes at operation stop.
- The setting temperature screen displays the character "End", which indicates termination of operation, with the FIXED TEMP and AUTO STOP lamps lighting on. Press the START/STOP key to terminate the timer operation mode. The screen returns to the initial setting screen.

To correct or check setting...

Changing the setting temperature or time during operation is possible by pressing the TIMER key. Use the "▼▲" to change the setting value. Press the ENTER key respectively after changing the setting.

Press the "▼" to display the setting temperature, operation mode and residual time on the setting temperature screen.

Auto Start Operation

Auto start operation procedure

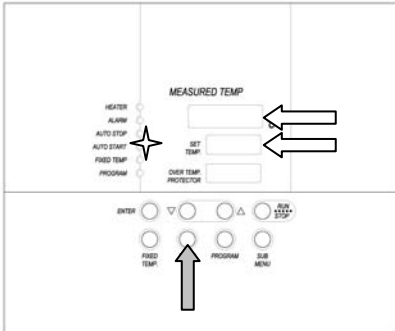

This operation is used to specify the period up to automatic start after power on.

1. Set start time

- ① Press the TIMER key on the initial screen.
Press the TIMER key again. The setting temperature display screen displays the character "Astr", which indicates the auto start operation, with blinking.
- ② Press the ENTER key.
The measurement temperature screen displays the character "SV", which indicates the temperature setting. The setting temperature screen displays the current setting temperature with blinking. The AUTO START lamp blinks, too.
- ③ Set the temperature using the "▼▲".
- ④ Press the ENTER key again.
The measurement temperature display screen displays the character "tim", which indicates the timer setting. The setting temperature display screen displays the current setting time with blinking.
- ⑤ Set the time using the "▼▲".

Timer function:

- The maximum setting time is "999 hours and 50 minutes".
- The time can be set in increments of a minute under 99 hours and 59 minutes.
- It can be set in increment of ten minutes over 100 hours.
- The "▼▲" can change the setting time quickly when it is pressed continuously. Press them discontinuously when fine adjustment is needed.

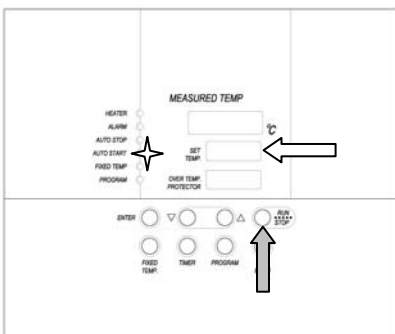

2. Start timer operation

- Press the START/STOP key for one second after deciding the time.
- Timer operation starts with the AUTO START lamp lighting on.

Auto Start Operation

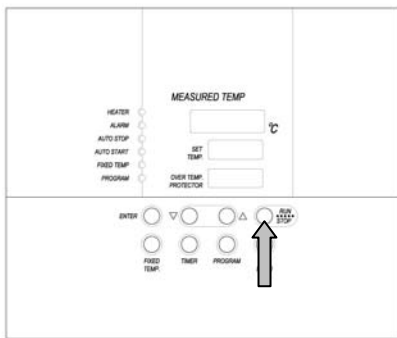

3. Stop/terminate timer operation

- The operation starts automatically at setting time.
- Press the START/STOP key for one second to stop or terminate operation. The screen returns to the initial setting screen.

To correct or check setting...

Changing the setting temperature or time during operation is possible by pressing the TIMER key. Use the "▼▲" to change the setting value. Press the ENTER key respectively after changing the setting. They are not changeable after the unit starts operation. In this case, stop the operation by pressing the START/STOP key, then set the value again.

Press the "▼" to display the setting temperature, operation mode and residual time on the setting temperature screen.

Program Operation

This operation is used to change the temperature according to the setting temperature and time.

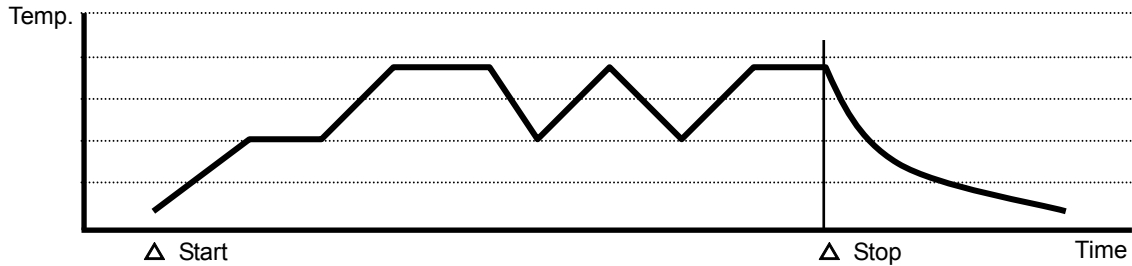

Program types

Six patterns of program types maximum can be input.

PrG1	-	1 program pattern using 30 steps maximum can be created.
PrG2	Pat1	2 program patterns using 15 steps maximum can be created.
	Pat2	
PrG3	Pat1	3 program patterns using 10 steps maximum can be created.
	Pat2	
	Pat3	

Before inputting program...

Input program patterns before program operation.

- ① Check the number of steps in a created program and their setting temperature/time. Use the program preparation sheet in pages 29 and 30 to check.
- ② Check the temperature rise/fall capability of the unit. Set the time within the capability above. Suppose, for instance, that in the unit which has capability of increasing or decreasing temperature by 50°C within 30 minutes, about 30 minutes is needed to increase or decrease temperature by 100°C from current temperature

Repeat function:

Repeat function is useful in case the operation uses the program repeating the same program steps. Refer to page27 for the function.

- ③ Check if the controller has sufficient free pattern for the number of steps to be created. The steps, however, using the repeat function mentioned above are not counted.

Program Operation

Program creation

The program pattern below is explained as an example.

1. Program pattern example

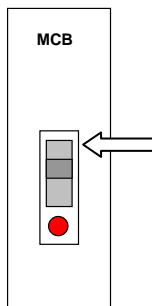
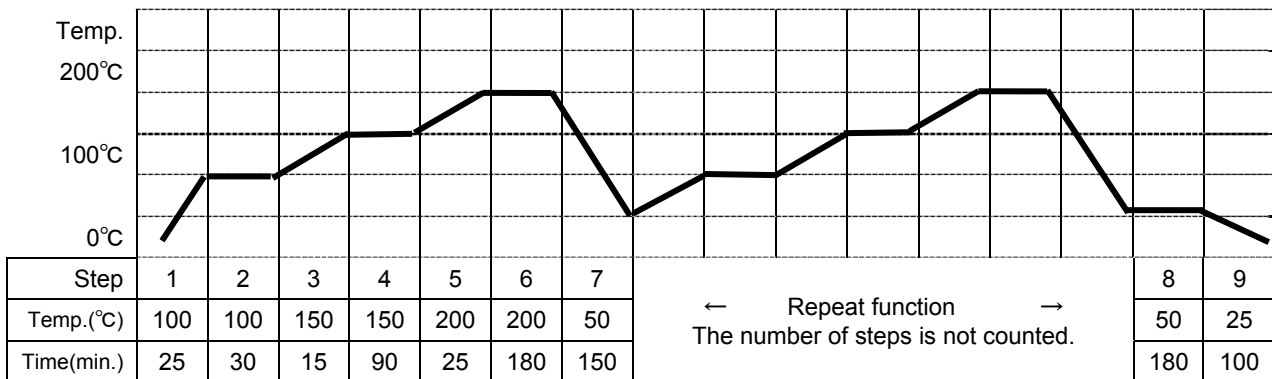

1. Turn on the power

- Turn on the power switch of the unit.
- The display on the controller lights on.
- The initial screen is displayed for about four seconds, then the measurement temperature (temperature in furnace) is displayed.
- ❖ The initial screen displays the software version information, sensor used and setting temperature of overheating prevention device.

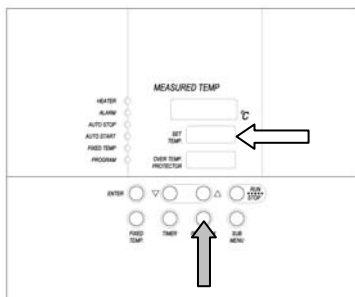

2. Select program mode/program pattern

- ① Press the PROGRAM key once.

The measurement temperature display screen displays the previous program mode.

Press the PROGRAM key again to display the next program mode.

- ② Select the mode and press the ENTER key.

- When PrG1 is selected, the measurement temperature display screen displays "End".
- When PrG2 is selected, the measurement temperature display screen displays the program pattern "PAT1". For the pattern of PrG2, select "1" or "2" using the "▲▼". Press the ENTER key again. The measurement temperature display screen displays "End".
- When PrG3 is selected, the measurement temperature display screen displays "PAT1". For the pattern of PrG3, select "1", "2" or "3" using the "▲▼". Press the ENTER key again. The measurement temperature display screen displays "End".
- ❖ Any of PrG1, PrG2 or PrG3 can be selectable in the program example above, where nine steps maximum are used.

Program Operation

The example shown below explains the method of program registration using PrG3.

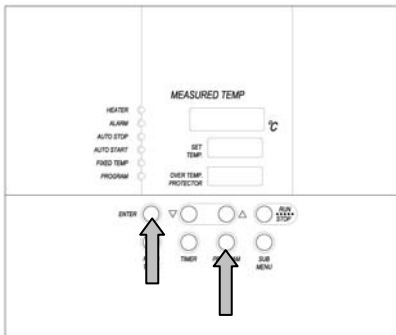

4. Register program

- ① Select PrG3 referring to 3 mentioned above..
- ② Input the number of steps, temperature and time for respective steps using the program creation sheet.
- ③ Press the ENTER key. The PA t 1 is displayed with blinking. ("End" is displayed if PrG1 is selected. In this case, go to ⑥)
- ④ Select the unused pattern from among Pat1, Pat2 and Pat3 using the "▲▼".
- ⑤ Press the ENTER key. "End" is displayed and the step number is also displayed with blinking.
 - ❖ "End" is a character which indicates the total step number to be used. "9" will be input here.
- ⑥ INPUT "9", which is the total step number to be used here, using the "▲▼".
- ⑦ Press the ENTER key. The character "SV-1", which indicates the setting temperature of the first step, is displayed. The current setting temperature is also displayed with blinking.
- ⑧ Set the temperature of the first step using the "▲▼". "100" is input here to set the temperature to 100°C.
- ⑨ Press the ENTER key. The character "t-1", which indicates the setting time of the first step, is displayed. The current setting time is also displayed with blinking.
 - ❖ Before setting the time, check the temperature rise/fall capability of unit.
 - ❖ For example, about 60 minutes is needed to increase the temperature from room temperature to 240°C for DP23C type (90minutes for DP33C type). When the current temperature is supposed to be 25°C, it takes about 3 minutes to increase the temperature by 1°C, accordingly takes about 60 minute until it reaches to 240°C. Add an extra considering the temperature stability time.
 - ❖ The setting time of timer in respective steps is 999 hours and 50 minutes maximum.
- ⑩ After the time is set, press the ENTER key.
- ⑪ The character "SV-2", which indicates the setting temperature of the second step, is displayed. In the same way, input the temperature and time for respective steps using the program creation sheet.

The different method is necessary where program repeat function is used. In this case, press the SUBMENU key after setting the time (t-7 in the example) in the step where the repeat operation is to be used (Step 7 in the example). This enters to the repeat function setting mode.

 - ❖ Follow the "Use program repeat function" in page 28 for the input method of program repeating function.
- ⑫ The screen returns to the initial setting screen after the setting of temperature and time in the final step is completed.

Verification run:

Make sure to check the setting temperature and time by operating the unit without load before performing actual run with samples.

Program Operation

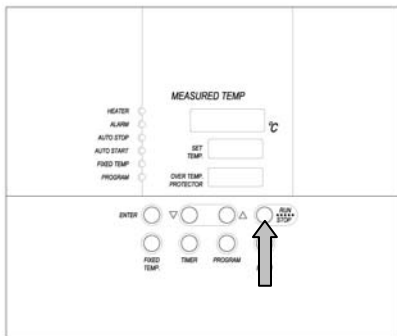

5. Start program operation

- Press the [START/STOP] key for about one second. The program operation previously set starts.
- The PROGRAM lamp lights on and the setting temperature screen displays the step currently under operation.
- ❖ Press the "▼" to check the setting temperature and residual time of step currently under operation on the setting temperature screen.

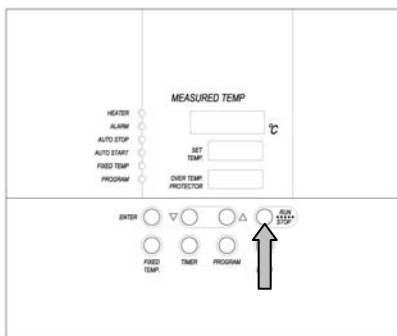

6. End program operation

- Buzzer continues to sound for about five minutes at operation stop.
- The measurement temperature screen displays the character "END", which indicates the termination of program.
- Press the [START/STOP] key to return to the initial screen.

Timer function:

- The maximum setting time is "999 hours and 50 minutes".
- The time can be set in increments of a minute under 99 hours and 59 minutes.
- It can be set in increment of ten minutes over 100 hours.
- The "▼▲" can change the setting time quickly when it is pressed continuously. Press them discontinuously when fine adjustment is needed.

To correct or check setting...

Press the [FIXED TEMP] key to correct the created program or to check the setting value. The screen returns to the former one, where correction or check is possible.

Last screen is displayed when the FIXED TEMP key is once pressed.

Note: Correction or check should be made on the program setting screen.

Wait operation in program operation

The succeeding step does not start in case the measurement temperature does not reach to, or exceeds the setting temperature when a program goes to the next step in program operation. This unit, however, is previously set to carry out the next step if the measurement temperature is within $\pm 3^{\circ}\text{C}$ of the setting temperature.

Program Operation

Use program repeat function

This section explains how to register the program repeat (repeating a program pattern) in program operation.

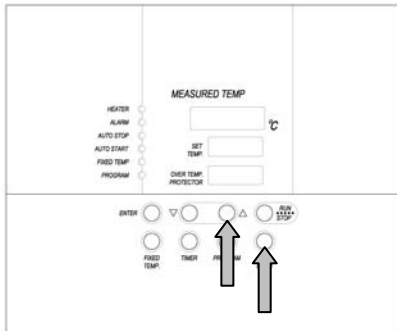

This section explains the registration procedure of program using repeat function in "4. Register program" above.

The procedure sets the step number to be repeated "PS-n" and repeating times "Pc-n"(n: step number)

- ① Press the SUBMENU key in stead of the ENTER key after setting the time (t-7 in the example) in the step where the repeat operation is to be used (Step 7 in the example). This enters to the repeat function setting mode.
- ② The measurement temperature screen displays the character "PS-n", which indicates the step to be repeated in the program pattern. The measurement temperature screen indicates "PS-7" in the example because repeat function is used at the seventh step. The step number 1 to 7 can be input in the setting temperature display screen. Enter the number (1 in the example) using the "▲▼".
- ③ Press the SUBMENU key. The measurement temperature screen displays the character "Pc-n", which indicates the repeating times. Enter the value of repeating times (2 in the example) with the "▲▼".
- ④ The screen goes to that for the next step when the SUBMENU key is pressed again. The screen to input the Sv-8 is displayed next in the example.

To correct or check setting...

Correction of setting during the repeat setting mode is impossible.

To correct or check the setting, end the setting of step currently input. Press the FIXED TEMP key after the temperature setting screen for the next step appears. The screen returns to the former one and re-setting is possible.

Note: Correction or check should be made on the program setting screen.

Program Operation

Programming Preparation Form 2

(Please use this form by making copies)

Register with:	PrG1 PrG2 PrG3	PA1 PA2 PA3	No.	
Project Name			Date	
			Programmer	

Input Value

	Temperature (°C)	Time (min.)	Repeat Function
Step 1		:	To/Times
Step 2		:	/
Step 3		:	/
Step 4		:	/
Step 5		:	/
Step 6		:	/
Step 7		:	/
Step 8		:	/
Step 9		:	/
Step 10		:	/
Step 11		:	/
Step 12		:	/
Step 13		:	/
Step 14		:	/
Step 15		:	/
Step 16		:	/
Step 17		:	/
Step 18		:	/
Step 19		:	/
Step 20		:	/
Step 21		:	/
Step 22		:	/
Step 23		:	/
Step 24		:	/
Step 25		:	/
Step 26		:	/
Step 27		:	/
Step 28		:	/
Step 29		:	/
Step 30		:	/

Other Functions

Use calibration offset function

Calibration offset is a function which corrects the difference between the temperature in furnace and that of controller (sensor temperature) if arises. The function parallel corrects the difference either to the plus or minus side within the whole temperature range of unit. The function can be set or cancelled by the SUBMENU key.

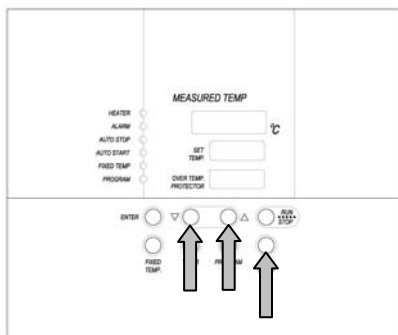
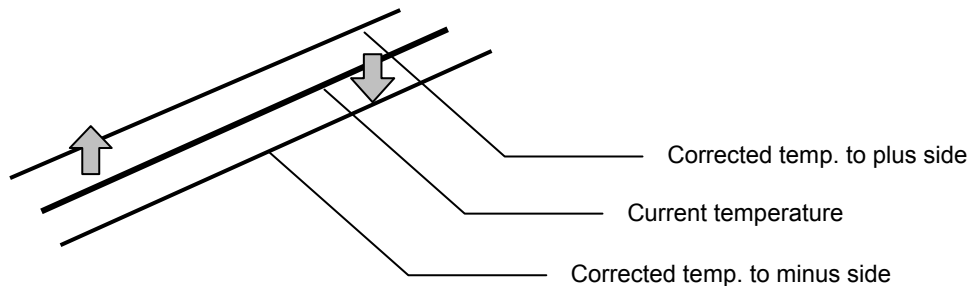

- ① Start operation with the target setting temperature. Check the temperature in furnace (temperature of sample) with a thermograph after it is stabilized.
 - ② Check the difference between the setting temperature and that in furnace (temperature of sample).
 - ③ Press the SUBMENU key. Select the character "cAL", which indicates the calibration offset, using the "▲▼", and then press the ENTER key.
 - ④ Input the difference using the "▲▼" and then press the ENTER key. This completes the setting.
- ❖ The setting range of offset correction temperature is +99°C to plus side and -99°C to minus side respectively. When it is set to the minus side, the temperature on the measurement temperature display screen falls by the setting temperature, while the temperature on furnace rises. When it is set to the plus side, the temperature on the measurement temperature display screen rises by the setting temperature, while the temperature on furnace falls.
 - ❖ The unit has two-point correction function, which performs offset between low-temperature zone and high-temperature zone. Please consult our local branch office when carrying out validation of temperature controller.

Use lock function

This function locks the operation status previously set. The function can be set or cancelled by the SUBMENU key.

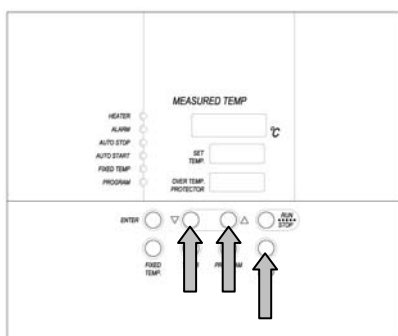

- ① Press the SUBMENU key. Select the character "Lock", which indicates the lock of setting value, using the "▲▼", and then press the ENTER key.
 - ② The setting temperature screen displays "off". The setting value is locked when it is turned to "on" using the "▲".
 - ③ Press the SUBMENU key again to cancel the lock. Select the character "Lock", which indicates the lock of setting value, using the "▲▼", and then press the ENTER key. Select "off" with the "▼" and then press the ENTER key to cancel the function.
- ❖ All keys other than the START/STOP and SUBMENU keys are lock when the lock function is on.

Vacuumizing and air intake

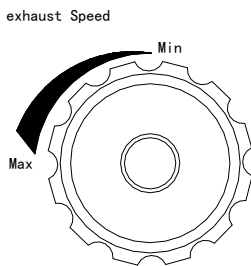

Exhaust speed regulating valve

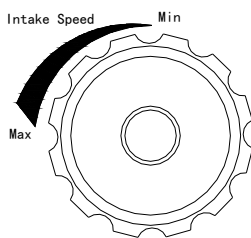

Intake speed regulating valve

Vacuumizing:

- 1) Turn the intake speed regulating valve CW to its end (close);
- 2) Turn the exhaust speed regulating valve CCW to its end, the exhaust speed is max. here;
- 3) Turn on vacuum pump for vacuumizing.

Air intake:

- 1) Turn the exhaust speed regulating valve CW to its end (close);
- 2) Turn off vacuum pump;
- 3) Slowly turn the intake speed regulating valve CCW to its end, the intake speed is max. here;
- 4) The door of chamber is unable to be opened when the inside pressure resumed to atmosphere pressure.

※ The operation procedures must be strictly followed.

WARNING!

If a problem occurs

-  If smoke or strange odor should come out of this unit for some reason, turn off the power key right away, and then turn off the circuit breaker and the main power. Immediately contact a service technician for inspection. If this procedure is not followed, fire or electrical shock may result. Never perform repair work yourself, since it is dangerous and not recommended.

Substances that cannot be used

-  Never use explosive substances, flammable substances and substances that include explosive or flammable ingredients in this unit. Explosion or fire may occur. (Refer to page45 "List of Dangerous Substances".)

CAUTION!

Do not step on this unit

-  Do not step on this unit. It will cause injury if this unit fall down or break.

Do not put anything on this unit

-  Do not put anything on this unit. It will cause injury if fall.

During a thunder storm

-  During a thunderstorm, turn off the power key immediately, then turn off the circuit breaker and the main power. If this procedure is not followed, fire or electrical shock may be caused.

When open/close door...

-  Do not get close to the traveling range of door when opening or closing it. It may hit your hands or head and result in an injury.

Keep door close during operation.

-  • The heater is heated abnormally if the door is left opened during operation. Make sure to operate the unit with the door closed.
- Do not leave the door open after operation in order to cool down the samples quickly. The heat in furnace may cause deformation of control panel or breakdown of control devices.

Do not use corrosive sample

-  Stainless steel SUS304 is used for interior; however, it may be corroded by strong acid etc. And the door packing made of silicon rubber may be corroded by some kind of solvent, e.g. alkaline, oil, halogen etc. Do not use the sample includes those.

Use under proper temperature range

-  Operational temperature range of **DP23C/33C** is **40°C to 240°C**.
- Operational temperature range of **DP43C/63C** is **40°C to 200°C**.
- Never set the temperature out of that.

Setting of sample

- ⊘ Since the withstand load of the attached shelf plate is about 15kg per one plate, do not set heavier sample than 15kg. When setting several sample, set them as dispersed as possible.
- ⚠ Too much sample setting could cause the improper control of the temperature. For keeping the proper temperature, keep more than 30% space against whole size of the shelf plate, and set the sample.

Do not put sample on the internal base

- ⊘ If sample is put directly on the base, device performance will be disturbed. Furthermore, internal temperature will abnormally rise and it will cause trouble. Never put sample on the base. Fix the shelf on the bracket then set sample on it.

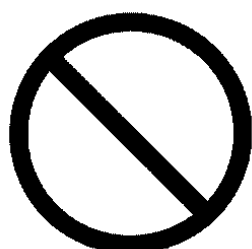

**Samples
on the base**

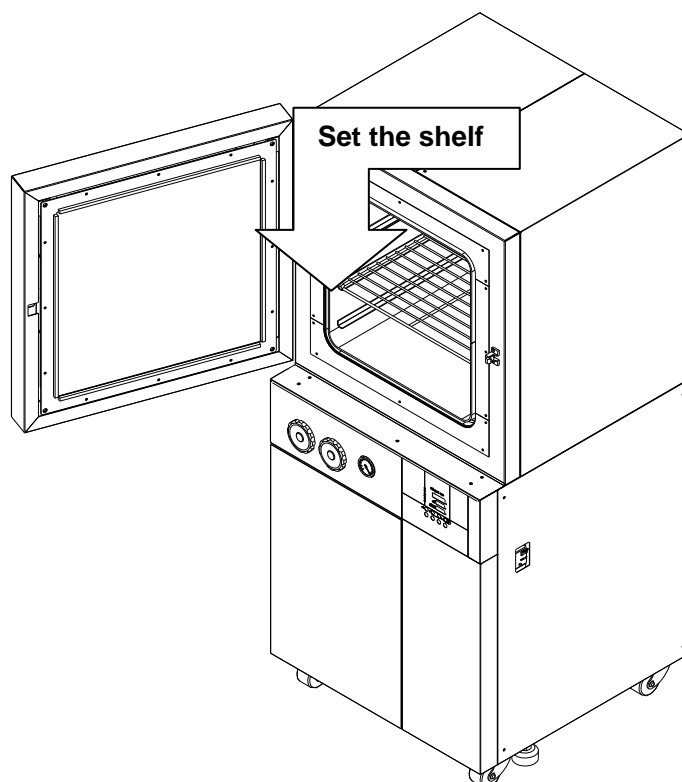

Recovering after power failure

- ⚠ When power is supplied after a power failure, the device automatically starts operation again with the same state as just before the power failure. It is danger that the device starts unattached operation after a power failure. We recommend for you to turn off the switch of this unit if a power failure occurs during operation.

Double stacking

- ⚠ Use the specified fittings included in the optional accessory for double stacking. Do not make direct double stacking.
- ⊘

After installing

- ⚠ It may cause injure to a person if this unit falls down or moves by the earthquake and the impact. etc.. To prevent, take measures that the unit cannot fall down.

Daily Inspection and Maintenance

For the safety use of this unit, please perform the daily inspection and maintenance without fail. Using the city water to this unit might attach dirt. Do inspect and maintain this point while performing daily inspection and maintenance.

WARNING!

- Disconnect the power cable from the power source when doing an inspection or maintenance unless needed.
- Perform the daily inspection and maintenance after returning the temperature of this unit to the normal one.
- Do not disassemble this unit.

CAUTION!

- Use a well-drained soft cloth to wipe dirt on this unit. Do not use benzene, thinner or cleanser for wiping. Do not scrub this unit. Deformation, deterioration or color change may result in.

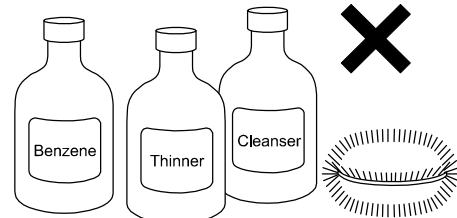

For any questions, contact the dealer who you purchased this unit from, or the nearest sales division in our company.

When not using this unit for long term / When disposing

CAUTION!

When not using this unit for long term...

- Turn off the power and disconnect the power cord.

WARNING!

When disposing...

- Keep out of reach of children.
- Remove the door and driving parts.
- Treat as large trash.

Environmental protection should be considered

We request you to disassemble this unit as possible and recycle the reusable parts considering to the environmental protection. The feature components of this unit and materials used are listed below.

Component Name	Material
Exterior Parts	
Outer covering	Steel plate SPCC (powder coating)
Furnace	Stainless steel
Heat insulation material	Glass wool
Door packing	Foam silicon rubber
Plates	PET resin film
Electrical Parts	
Heater	SUS pipe heater
Circuit boards	Board, Condenser, Transformer and other
Power cord, Wiring	Synthetic rubber or resin coated wiring materials

Safety Device and Error Code

This unit has an automatic diagnosis function built in the controller and safety devices independent of the controller. The table below shows the cause and the solution method when the safety device operates.

Error Code:

When an abnormal condition occurs, an error code appears and the alarm lamp lights in the controller, the buzzer sounds simultaneously. Record the error code and turn off the power of device immediately.

Safety Device	Notify	Cause/Solution
Sensor trouble detection	"ALARM" lamp lights on, "Er.01" appears	<ul style="list-style-type: none"> • Temperature sensor is broken or disconnected. • Make a call for service.
SSR short-circuit detection	"ALARM" lamp lights on, "Er.02" appears	<ul style="list-style-type: none"> • Triac is in short-circuit • Make a call for service.
Heater disconnecting detection	"ALARM" lamp lights on, "Er.03" appears	<ul style="list-style-type: none"> • Heater is disconnected. • Make a call for service.
Memory error	"ALARM" lamp lights on, "Er.15" appears	<ul style="list-style-type: none"> • Failure in internal memory. • Make a call for service.
Internal communication error	"ALARM" lamp lights on, "Er.17" appears	<ul style="list-style-type: none"> • Failure in internal communication or temperature inputting circuit. • Make a call for service.
Overheating	"ALARM" lamp lights on, "Er.19" appears	<ul style="list-style-type: none"> • Overheating prevention device is in operation. • Reset the power supply, and then adjust the setting temperature of the overheating protection device. • If the state does not recover, make a call for service.
Measurement temperature error	"ALARM" lamp lights on, "----" appears	<ul style="list-style-type: none"> • Measurement value is out of display range. • Make a call for service.

Trouble Shooting

Before call us...

Condition	Possible Causes
The device does not start when turning on the power switch.	<ul style="list-style-type: none">• Power plug is not connected to the receptacle correctly.• Power failure.
Temperature fluctuates during the operation.	<ul style="list-style-type: none">• Too much samples.• Wind from air conditioner directly blows.• The change of ambient temperature is remarkable.• Samples are too moist.• The power supply voltage is lower than the proper value.

In the case if the error other than listed above occurred, turn off the power switch and primary power source immediately. Contact the shop of your purchase or nearest Yamato Scientific Service Office.

In Case of Request for Repair

If the failure occurs, stop the operation, turn OFF the power switch, and unplug the power plug. Please contact the sales agency that this unit was purchased, or the Yamato Scientific's sales office.

< Check following items before contact >

- ◆ Model Name of Product
 - ◆ Production Number
 - ◆ Purchase Date
 - ◆ About Trouble (in detail as possible)
- } See the production plate attached to this unit.

Minimum Retention Period of Performance Parts for Repair

The minimum retention period of performance parts for repair of this unit is 7 years after discontinuance of this unit.

The "performance part for repair" is the part that is required to maintain this unit.

	DP23C	DP33C	DP43C	DP63C
Method	Pressure relief and wall heating			
Temperature control range	40°C to 240°C		40°C to 200°C	
Temperature adjustment accuracy	±1.5°C (Middle of furnace, Set temp.: 240°C,)		±1°C (Middle of furnace, Set temp.: 200°C,)	
Temperature rise time	Room temp. to 240°C		Room temp. to 200°C	
	Approx. 60min.	Approx. 90min.	Approx. 80min.	Approx. 120min.
❖ Temperature fall time	(240 to 50°C)		(200 to 50°C)	
	Approx. 250min.	Approx. 320min.	Approx. 550min.	Approx. 600min.
Heater	SUS pipe heater			
	0.68kw	1.05kw	2.25kw	3.15 kw
Controller	type VS6			
Temperature control system	PID control for heater output by microcomputer			
Setting system	Digital setting by menu key and up/down keys			
Operation mode	Fixed temperature, Quick auto stop, Auto stop, Auto start, Program operation			
Sensor	K-thermocouple			
Additional functions	Lock function, Auto recovering after power failure, Calibration offset			
Self-diagnostic functions	Failure of Sensor, heater, SSR, memory, internal communication, temperature inputting circuit, automatic overheating prevention device, overheating prevention device, measurement temperature			
Safety device	Overheating prevention device			
External dimensions (W × D × H mm)	200×250×200	300×300×300	450×450×450	600×600×600
Internal dimensions (W × D × H mm)	400×410×682	510×460×782	670×669×1500	820×819×1650
Capacity	10L	27 L	91 L	216L
Door	Single door, silicon packing			
Power supply (50Hz)	220V AC single phase			
	4A	5A	10.5A	14.5A
Weight	Approx. 43Kg	Approx. 69Kg	Approx. 190Kg	Approx. 290Kg
Accessories	Shelf (withstand load: 15kg/one shelf)			
	× 2			
	Instruction manual			

- ❖ The performance under the power supply condition of AC 220V are shown here.
- ❖ The usable ambient temperature of the unit is from 5°C to 35°C.
- ❖ The temperature fall time here shows the reference value.

DP23C/33C

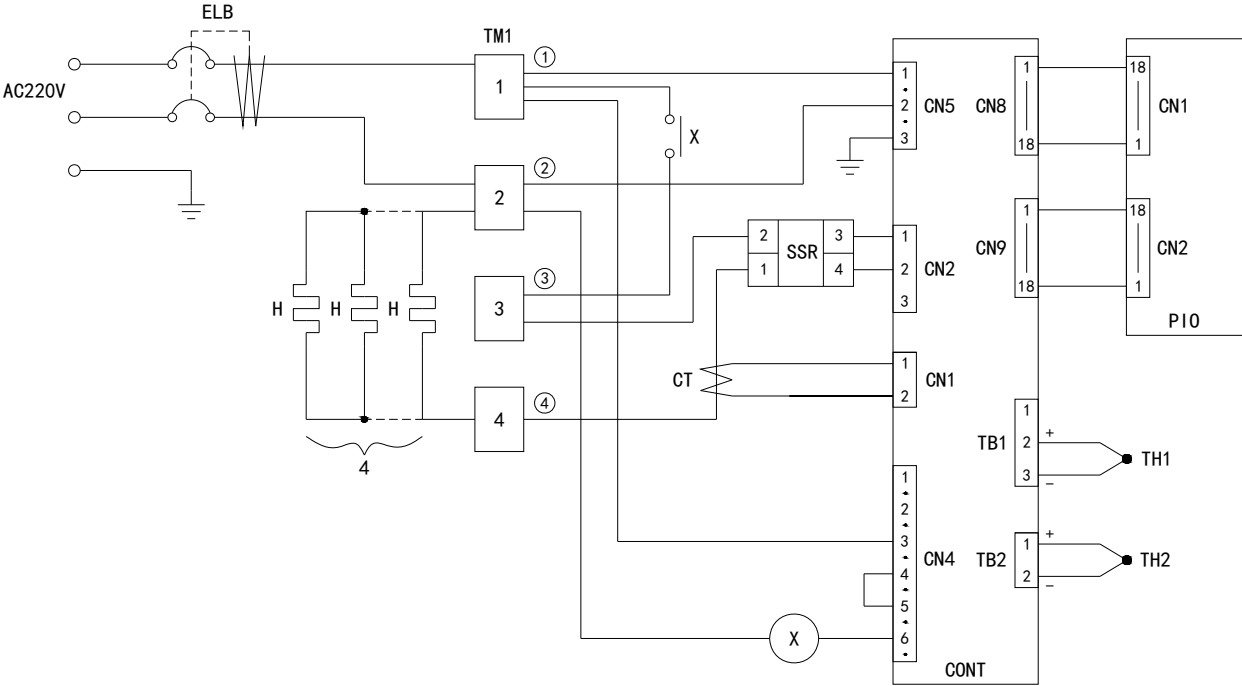

Symbol	Part name	Symbol	Part name
MCB	Main circuit breaker	CONT	Control board
TM1	Terminal block	PIO	Display circuit board
H	Heater	TH1	Sensor for control
X	Main relay	TH2	Sensor for overheating prevention
SSR	Solid state relay	CT	Current transformer

DP43C/63C

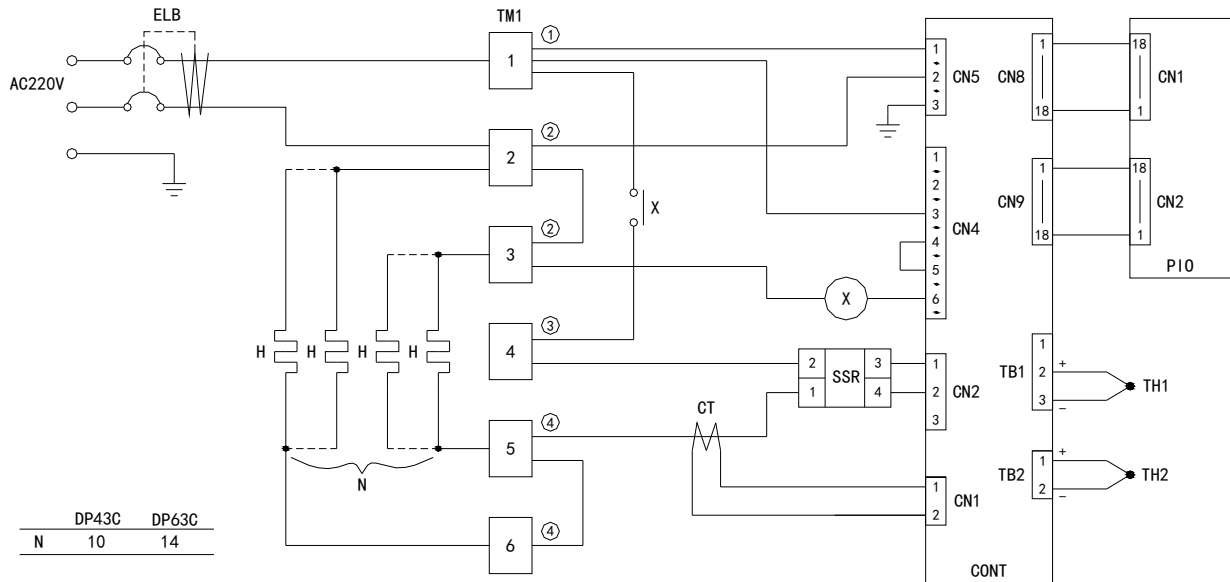

Symbol	Part name	Symbol	Part name
MCB	Main circuit breaker	CONT	Control board
TM1	Terminal block	PIO	Display circuit board
H	Heater	TH1	Sensor for control
X	Main relay	TH2	Sensor for overheating prevention
SSR	Solid state relay	CT	Current transformer

DPC temperature rising curve

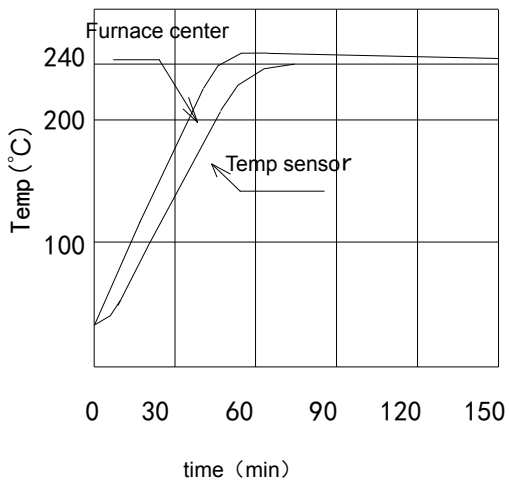

DP23C temperature rising characteristics

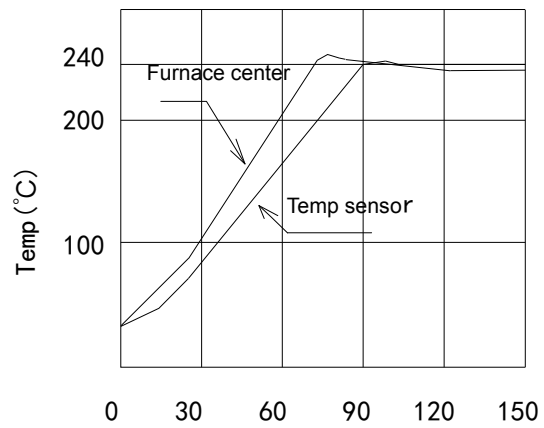

DP33C temperature rising characteristics

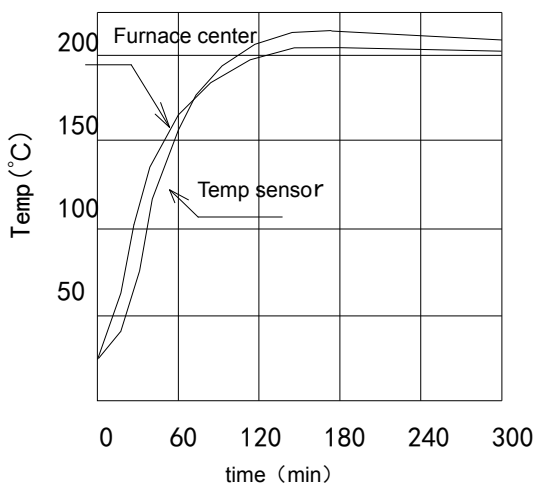

DP23C temperature rising characteristics

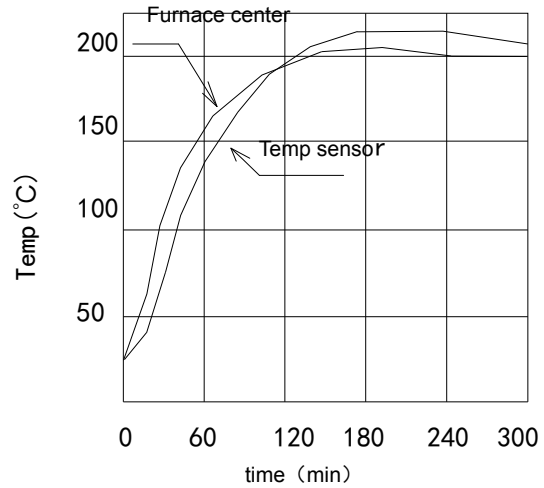

DP23C temperature rising characteristics

DPC temperature /Pressure falling curve

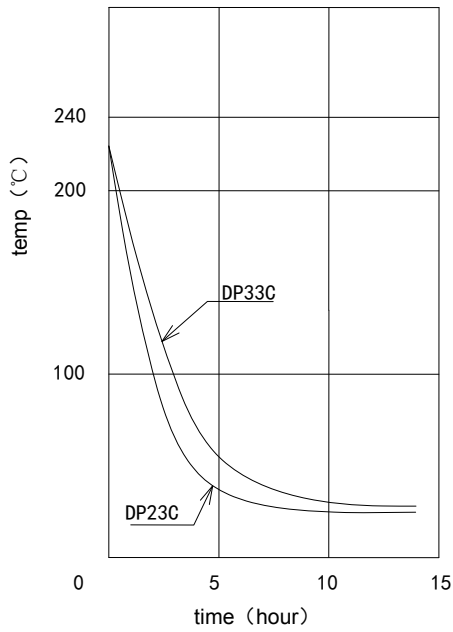

DP23C/33C temperature falling characteristics (center of furnace)

[Vaccum state 1Torr (0.1kPa) 以下]

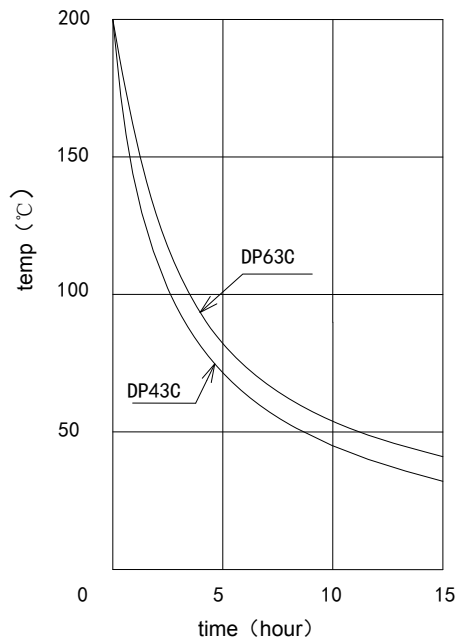

DP43C/63C temperature falling characteristics (center of furnace)

[Vaccum state 1Torr (0.1kPa) 以下]

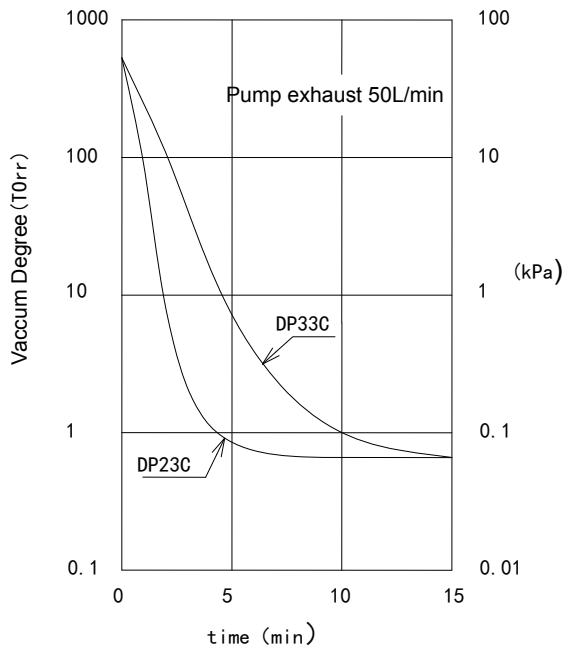

DP23C/33C pressure falling characteristics

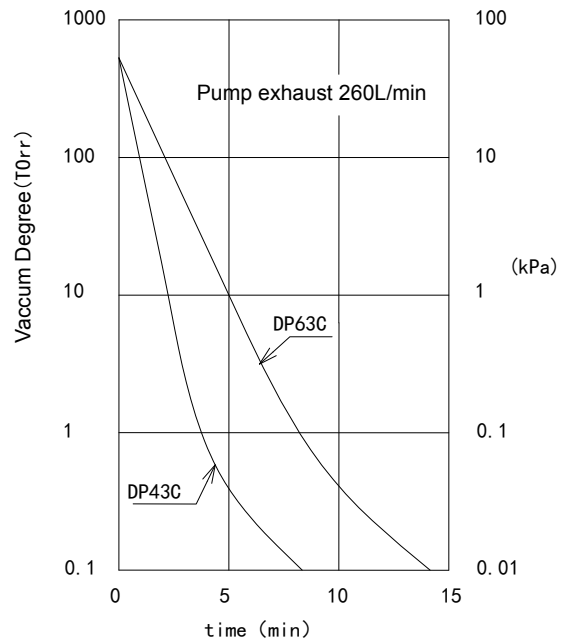

DP43C/63C pressure falling characteristics

Replacement Parts Table

DP23C/33C/43C/63C Common Use Parts

Mark	Part Name	Specification	Manufacturer	Code No.
TH1, 2	Sensor	Φ3.2*55*2000	Yamato Scientific	H020401001
CONT	VS6 PLANAR board	VS6	Yamato Scientific	B011401053
PIO	VS4 display circuit board	VS3,4	Yamato Scientific	B011402007
	Tough card	UL20861-18N*300mm	Yamato Scientific	B011299041
X	Main relay	HF116F-2/220AL1HSTFW	Yamato Scientific	A011002002
SSR	Solid state relay	KS15/D-38Z25-L	Yamato Scientific	A011006023
CT	Current transformer	URD CTL-6-S-H	Yamato Scientific	B010509001
	Hook	DN93-40030	Yamato Scientific	B080702006
	Hinge	L=65	Yamato Scientific	A080701011
	Filter	DP43S-30400	Yamato Scientific	B100102021
	Vacuum gauge	GZ46-KK-02M-C	Yamato Scientific	A042300020
	Control panel	T0305.02.01-11/12(VS4)	Yamato Scientific	A100101003
	Volume panel	T0305.02.01-13/14	Yamato Scientific	H020401059

DP23C Replacement Parts

Mark	Part Name	Specification	Manufacturer	Code No.
H	Heater	SUS board heater 200W	Yamato Scientific	21020501027
		SUS board heater 80W	Yamato Scientific	21020501028
	Power cord kit	2.0sq 3p plug	Yamato Scientific	A011209001
ELB	Main circuit breaker	BV-DN 1P+N 16A 30mA	Mitsubishi	A011209001

DP33C Replacement Parts

Mark	Part Name	Specification	Manufacturer	Code No.
H	Heater	SUS board heater 300W	Yamato Scientific	H020501029
		SUS board heater 105W	Yamato Scientific	H020501030
	Power cord kit	2.0sq 3p plug	Yamato Scientific	A011209001
ELB	Main circuit breaker	BV-DN IP+N 10A 30mA	Mitsubishi	A010410007

DP43C Replacement Parts

Mark	Part Name	Specification	Manufacturer	Code No.
H	Heater	220V 225W	Yamato Scientific	H020401088
	Door packing	DP41-40720	Yamato Scientific	B081903009
	Power cord kit	12AWG*3C (3*3.31mm ²)	Yamato Scientific	A011210001
ELB	Main circuit breaker	BV-DN IP+N 16A 30mA	Mitsubishi	A010410004

DP63C Replacement Parts

Mark	Part Name	Specification	Manufacturer	Code No.
H	Heater	220V 225W	Yamato Scientific	H020401088
	Window packing	DP43S-30400	Yamato Scientific	B080709001
	Door packing	DP61-40390	Yamato Scientific	B081903023
	Power cord kit	12AWG*3C (3*3.31mm ²)	Yamato Scientific	A011210001
ELB	Main circuit breaker	BV-DN IP+N 20A 30mA	Mitsubishi	A010410001

List of Dangerous Substances



Never use explosive substances, flammable substances and substances that include explosive or flammable ingredients in this unit.

EXPLOSIVE

EXPLOSIVE:	Ethylene glycol dinitrate (nitro glycol), Glycerin trinitrate (nitroglycerine), Cellulose nitrate (nitrocellulose), and other explosive nitrate esters
	Trinitrobenzene, Trinitrotoluene, Trinitrophenol (picric acid), and other explosive nitro compounds
	Acetyl hidroperoxide (peracetic acid), Methyl ethyl ketone peroxide, Benzyl peroxide, and other organic peroxides

FLAMMABLE

IGNITING:	Lithium (metal), Potassium (metal), Sodium (metal), Yellow phosphorus, Phosphorus sulfide, Red phosphorus, Celluloid compounds, Calcium carbide, Lime phosphate, Magnesium (powder), Aluminum (powder), Powder of metals other than magnesium and aluminum, Sodium hydrosulfite
OXIDIZING:	Potassium chlorate, Sodium chlorate, Ammonium chlorate, and other chlorate
	Potassium perchlorate, Sodium perchlorate, Ammonium perchlorate, and other perchlorate
	Potassium peroxide, Sodium peroxide, Barium peroxide, and other inorganic peroxide
	Potassium nitrate, Sodium nitrate, Ammonium nitrate, and other nitrate
	Sodium chlorite and other chlorites
	Calcium hypochlorite and other hypochlorites
INFLAMMABLE LIQUID:	Ethyl ether, Gasoline, Acetaldehyde, Propylene chloride, Carbon disulfide, and other flammable substances having a flash point of lower than -30°C
	Normal hexane, ethylene oxide, acetone, benzene, methyl ethyl ketone, and other flammable substances having a flash point of -30°C or higher but lower than 0°C
	Methanol, Ethanol, Xylene, Pentyl acetate (amyl acetate), and other flammable substances having a flash point of 0°C or higher but lower than 30°C
	Kerosene, Light oil (gas oil), Oil of turpentine, Isopentyl alcohol (isoamyl alcohol), Acetic acid, and other flammable substances having a flash point of 30°C or higher but lower than 65°C
FLAMMABLE GAS:	Hydrogen, Acetylene, Ethylene, Methane, Propane, Butane, and other flammable substances which assume a gaseous state at 15°C and 1 atm

Responsibility

Please follow the instructions in this document when using this unit. Yamato Scientific has no responsibility for the accidents or breakdown of device if it is used with a failure to comply. Never conduct what this document forbids. Unexpected accidents or breakdown may result in.

Note

- ◆ The contents of this document may be changed in future without notice.
- ◆ Any books with missing pages or disorderly binding may be replaced.

Instruction Manual for

Vacuum Drying Oven

DP 23C/33C/43C/63C

Second Edition Aug. 30, 2018

Revision Jun. 28, 2022

YAMATO SCIENTIFIC CO., LTD.
Harumi Triton Square Y-36F, 1-8-11 Harumi,
Chuo-ku, Tokyo 104-6136, Japan
Tel : +81-3-5548-7122
Fax : +81-3-5548-0132
<https://www.yamato-scientific.com/>